

SSC-JE

Staff Selection Commission

Junior Engineer

Electrical Engineering

Topicwise Objective Solved Questions

Volume-I

Previous Years Solved Papers : 2007-2025

SSC-JE : Paper-1 (Preliminary Examination)

*Also useful for **RRB-JE Mains** as well as various **public sector examinations**
and other competitive examinations*



www.madeeasypublications.org



MADE EASY Publications Pvt. Ltd.

Corporate Office: 44-A/4, Kalu Sarai (Near Hauz Khas Metro Station), New Delhi-110016

E-mail: infomep@madeeasy.in

Contact: 9021300500

Visit us at: www.madeeasypublications.org

**SSC-JE : Paper-I
Electrical Engineering Previous Years Solved Papers : Volume-I**

Copyright © by MADE EASY Publications Pvt. Ltd.

All rights are reserved. No part of this publication may be reproduced, stored in or introduced into a retrieval system, or transmitted in any form or by any means (electronic, mechanical, photo-copying, recording or otherwise), without the prior written permission of the above mentioned publisher of this book.

First Edition: 2016

Second Edition: 2018

Third Edition: 2019

Fourth Edition: 2020

Fifth Edition: 2021

Reprint: 2022

Sixth Edition : 2023

Seventh Edition : 2024

Eighth Edition: 2024 (Sept.)

Ninth Edition: 2025

Tenth Edition: 2026

MADE EASY PUBLICATIONS Pvt. Ltd. has taken due care in collecting the data and providing the solutions, before publishing this book. In spite of this, if any inaccuracy or printing error occurs then MADE EASY PUBLICATIONS owes no responsibility. MADE EASY PUBLICATIONS will be grateful if you could point out any such error. Your suggestions will be appreciated.

© All rights reserved by MADE EASY PUBLICATIONS. No part of this book may be reproduced or utilized in any form without the written permission from the publisher.

Preface

Staff Selection Commission-Junior Engineer has always been preferred by Engineers due to job stability. SSC-Junior Engineer examination is conducted every year. MADE EASY team has deeply analyzed the previous exam papers and observed that a good percentage of questions are repetitive in nature, therefore it is advisable to solve previous years papers before a candidate takes the exam.



B. Singh (Ex. IES)

The SSC JE exam is conducted in two stages as shown in table given below.

Papers	Subject	Maximum Marks	Duration
Stage 1: Paper-I : Objective type	(i) General Intelligence & Reasoning	50 Marks	2 hours
	(ii) General Awareness	50 Marks	
	(iii) General Engineering : Electrical	100 Marks	
Stage 2: Paper-II : Objective Type	General Engineering : Electrical	300 Marks	2 hours

Note: In Paper-I, every question carry one mark and there is negative marking of $\frac{1}{4}$ marks for every wrong answer. Candidates shortlisted in Stage 1 are called for Stage 2. On the basis of combined score in Stage 1 and Stage 2, final merit list gets prepared.

MADE EASY has taken due care to provide complete solution with accuracy. Apart from Staff Selection Commission-Junior Engineer, this book is also useful for Public Sector Examinations and other competitive examinations for engineering graduates.

I have true desire to serve student community by providing good source of study and quality guidance. Any suggestion from the readers for improvement of this book is most welcome.

B. Singh (Ex. IES)

Chairman and Managing Director

MADE EASY Group

Syllabus of Engineering Subjects

(For both Objective and Conventional Type Papers)

Electrical Engineering

Basic concepts: Concepts of resistance, inductance, capacitance, and various factors affecting them. Concepts of current, voltage, power, energy and their units.

Circuit law: Kirchhoff's law, Simple Circuit solution using network theorems.

Magnetic Circuit: Concepts of flux, mmf, reluctance, Different kinds of magnetic materials, Magnetic calculations for conductors of different configuration e.g. straight, circular, solenoidal, etc. Electromagnetic induction, self and mutual induction.

AC Fundamentals: Instantaneous, peak, R.M.S. and average values of alternating waves, Representation of sinusoidal wave form, simple series and parallel AC Circuits consisting of R, L and C, Resonance, Tank Circuit. Poly Phase system – star and delta connection, 3-phase power, DC and sinusoidal response of R-L and R-C circuit.

Measurement and Measuring Instruments: Measurement of power (1 phase and 3-phase, both active and re-active) and energy, 2 wattmeter method of 3-phase power measurement. Measurement of frequency and phase angle. Ammeter and voltmeter (both moving coil and moving iron type), extension of range wattmeter, Multimeters, Megger, Energy meter AC Bridges. Use of CRO, Signal Generator, CT, PT and their uses. Earth fault detection.

Electrical Machines: (a) D.C. Machine – Construction, Basic Principles of D.C. motors and generators, their characteristics, speed control and starting of D.C. Motors. Method of braking motor, Losses and efficiency of D.C. Machines. (b) 1 phase and 3 phase transformers – Construction, Principles of operation, equivalent circuit, voltage regulation, O.C. and S.C. Tests, Losses and efficiency. Effect of voltage, frequency and wave form on losses. Parallel operation of 1 phase /3 phase transformers. Auto transformers. (c) 3 phase induction motors, rotating magnetic field, principle of operation, equivalent circuit, torque-speed characteristics, starting and speed control of 3 phase induction motors. Methods of braking, effect of voltage and frequency variation on torque speed characteristics. Fractional Kilowatt Motors and Single Phase Induction Motors: Characteristics and applications.

Synchronous Machines: Generation of 3-phase e.m.f. armature reaction, voltage regulation, parallel operation of two alternators, synchronizing, control of active and reactive power. Starting and applications of synchronous motors.

Generation, Transmission and Distribution: Different types of power stations, Load factor, diversity factor, demand factor, cost of generation, inter-connection of power stations. Power factor improvement, various types of tariffs, types of faults, short circuit current for symmetrical faults. Switchgears – rating of circuit breakers, Principles of arc extinction by oil and air, H.R.C. Fuses, Protection against earth leakage/over current, etc. Buchholtz relay, Merz-Price system of protection of generators & transformers, protection of feeders and bus bars. Lightning arresters, various transmission and distribution system, comparison of conductor materials, efficiency of different system. Cable – Different type of cables, cable rating and derating factor.

Estimation and Costing: Estimation of lighting scheme, electric installation of machines and relevant IE rules. Earthing practices and IE Rules.

Utilization of Electrical Energy: Illumination, Electric heating, Electric welding, Electroplating, Electric drives and motors.

Basic Electronics: Working of various electronic devices e.g. P N Junction diodes, Transistors (NPN and PNP type), BJT and JFET. Simple circuits using these devices.



Electrical Engineering : Volume-I
Previous Years Objective Solved Papers

Chapter 1

**Electric Circuits and
Magnetic Circuits..... 1-236**

- 1. Basics 1
- 2. Circuit Laws26
- 3. AC Fundamentals & Transient Analysis.....35
- 4. Network Theorems52
- 5. Resonance & Magnetically Coupled Circuits.....61
- 6. Three Phase Systems.....66
- 7. Magnetic Circuits.....69
- 8. Miscellaneous87

Chapter 2

**Measurement and Measuring
Instruments 237-301**

- 1. Characteristics of Measuring Instruments,
Error Analysis 237
- 2. Electromechanical Indicating Instruments..... 238
- 3. Measurement of Resistance & Potentiometers 247
- 4. AC Bridges..... 249
- 5. Measurement of Power and Power Factor 252
- 6. Energy Meters..... 255
- 7. Instrument Transformers 258
- 8. Transducers 259
- 9. Electronic Instruments 261
- 10. Miscellaneous 264



Electric Circuits and Magnetic Circuits

1. Basics

1.1 A circuit component that opposes the change in circuit voltage is

- (a) resistance (b) capacitance
(c) inductance (d) all the above

[SSC-JE: 2008]

1.2 Two heaters rated at 1000 W, 250 V each are connected in series across a 250 V, 50 Hz AC mains. The total power drawn from the supply would be

- (a) 1000 watts (b) 500 watts
(c) 250 watts (d) 2000 watts

[SSC-JE: 2008]

1.3 Specific resistance of a conductor depends upon

- (a) dimension of the conductor
(b) composition of conductor material
(c) resistance of the conductor
(d) both (a) and (b)

[SSC-JE: 2009]

1.4 A wire has a resistance 10Ω . It is stretched by one-tenth of the original length. Then its resistance will be

- (a) 10Ω (b) 12.1Ω (c) 9Ω (d) 11Ω

[SSC-JE: 2010]

1.5 The ratio of resistances of a 100 W, 220 V lamp to that of a 100 W, 110 V lamp will be equal to

- (a) 4 (b) 2 (c) $\frac{1}{2}$ (d) $\frac{1}{4}$

[SSC-JE: 2010]

1.6 If four $10 \mu\text{F}$ capacitors are connected in parallel the net capacitance is

- (a) $2.5 \mu\text{F}$ (b) $40 \mu\text{F}$
(c) $20 \mu\text{F}$ (d) $115 \mu\text{F}$

[SSC-JE: 2010]

1.7 Three resistances 5Ω each are connected in star. Values of equivalent delta resistances are

- (a) 1.5Ω each (b) 2.5Ω each
(c) $5/3 \Omega$ each (d) 15Ω each

[SSC-JE: 2012]

1.8 Match the items given in List-I and those in List-II (Temperature

coefficient of Resistance). Select your answer using codes given in the lists:

- | List-I | List-II |
|---|---------------------|
| (1) Aluminium | P. Negligibly small |
| (2) Manganin | Q. Positive |
| (3) Carbon | R. Negative |
| (a) (1) \rightarrow R, (2) \rightarrow Q, (3) \rightarrow P | |
| (b) (1) \rightarrow Q, (2) \rightarrow P, (3) \rightarrow R | |
| (c) (1) \rightarrow P, (2) \rightarrow Q, (3) \rightarrow R | |
| (d) (1) \rightarrow R, (2) \rightarrow P, (3) \rightarrow Q | |

[SSC-JE: 2012]

1.9 The resistance of insulation, in general, _____ with temperature rise.

- (a) decreases
(b) increases rapidly
(c) increases slowly
(d) does not change

[SSC-JE: 2012]

1.10 Which of the following materials possesses the least resistivity?

- (a) Iron (b) Manganin
(c) Aluminium (d) Copper

[SSC-JE: 2012]

1.11 The wires A and B of the same material but of different lengths L and $2L$ have the radius r and $2r$ respectively. The ratio of specific resistance will be

- (a) 1 : 4 (b) 1 : 8 (c) 1 : 1 (d) 1 : 2

[SSC-JE: 2012]

1.12 The equivalent resistance between terminals X and Y of the network shown is

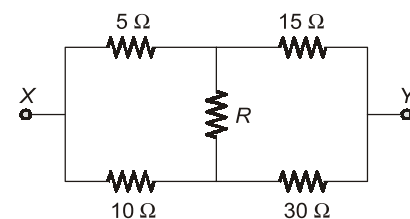

- (a) 8Ω (b) $\frac{100}{3} \Omega$
(c) $\frac{40}{3} \Omega$ (d) $\frac{20}{9} \Omega$

[SSC-JE: 2012]

1.13 A $10 \mu\text{F}$ and a $20 \mu\text{F}$ capacitor are in series. The combination is

supplied at 150 V from a sinusoidal voltage source. The voltage across the $20 \mu\text{F}$ capacitor is then

- (a) 75 V (b) 125 V (c) 100 V (d) 50 V

[SSC-JE: 2012]

1.14 The wave shape of current flowing through an inductor is

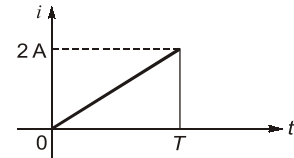

The wave shape of voltage drop (v) across the inductor is

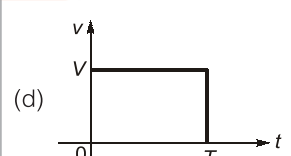
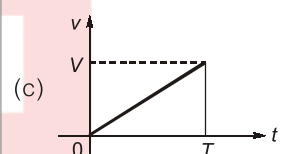
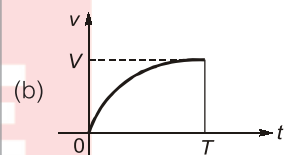
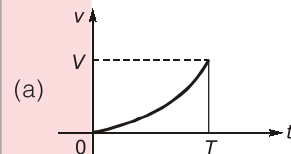

[SSC-JE: 2012]

1.15 A 20 micro farad capacitor is connected across an ideal voltage source. The current in the capacitor

- (a) will be very high at first, then exponentially decay and at steady state will become zero.
(b) none of these are true.
(c) will be zero at first, then exponentially rise.
(d) will be very high at first, then exponentially decay.

[SSC-JE: 2012]

1.16 Three $3 \mu\text{F}$ capacitor are in series. A $6 \mu\text{F}$ capacitor is in parallel with this series arrangement. The equivalent capacitance of this combination is

- (a) $7 \mu\text{F}$ (b) $15 \mu\text{F}$
(c) $3.6 \mu\text{F}$ (d) $1 \mu\text{F}$

[SSC-JE : 2013]

1.17 In the circuit, V is the input voltage applied across the capacitor of 2 F . Current through the capacitor is

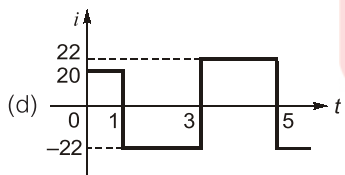
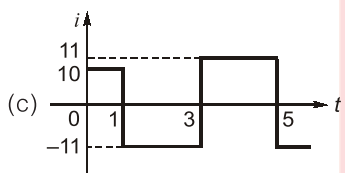
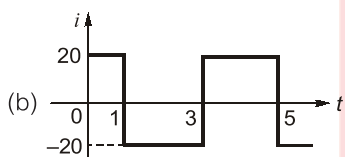
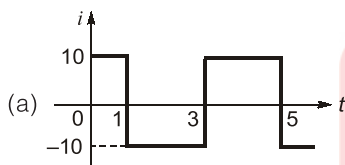
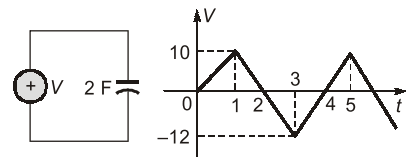

[SSC-JE : 2013]

1.18 Ampere-second is the unit of

- (a) emf (b) power
(c) electric charge (d) energy

[SSC-JE : 2013]

1.19 Three inductors each of 60 mH are connected in delta. The value of inductance of each arm of the equivalent star connection is

- (a) 10 mH (b) 15 mH
(c) 20 mH (d) 30 mH

[SSC-JE : 2013]

1.20 Two 2000Ω , 2 watt resistors are connected in parallel. Their combined

resistance value and wattage rating are
(a) 1000Ω , 2 watt (b) 1000Ω , 4 watt
(c) 2000Ω , 4 watt (d) 2000Ω , 2 watt

[SSC-JE : 2013]

1.21 We have three resistances each of value 1Ω , 2Ω and 3Ω . If all the three resistances are to be connected in a circuit, how many different values of equivalent resistance are possible?

- (a) Five (b) Six
(c) Seven (d) Eight

[SSC-JE : 2013]

1.22 An electric heater draws 1000 W from a 250 V source. The power drawn from a 200 V source is

- (a) 800 W (b) 640 W
(c) 1000 W (d) 1562.5 W

[SSC-JE : 2013]

1.23 The material to be used to manufacture a standard resistor should be of

- (a) low resistivity.
(b) high resistivity and low temperature coefficient.
(c) high temperature coefficient.
(d) low resistivity and high temperature.

[SSC-JE : 2014 (FN)]

1.24 Four resistance 2Ω , 4Ω , 5Ω , 20Ω are connected in parallel. Their combined resistance is

- (a) 1Ω (b) 2Ω (c) 4Ω (d) 5Ω

[SSC-JE : 2014 (FN)]

1.25 A 200 W , 200 V bulb and a 100 W , 200 V bulb are connected in series and the voltage of 400 V is applied across the series connected bulbs. Under this condition

- (a) 100 W bulb will be brighter than 200 W bulb.
(b) 200 W bulb will be brighter than 100 W bulb.
(c) Both the bulbs will have equal brightness.
(d) Both the bulbs will be darker than when they are connected across rated voltage.

[SSC-JE : 2014 (FN)]

1.26 In the network shown, if one of the 4Ω resistances is disconnected, when the circuit is active, the current flowing now will

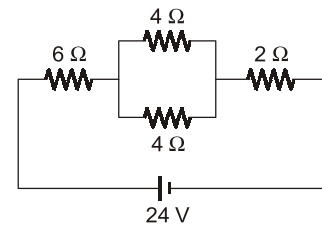

- (a) increase very much
(b) decrease
(c) be zero
(d) increase very slightly

[SSC-JE : 2014 (FN)]

1.27 Which of the following is non-linear circuit parameter?

- (a) Transistor
(b) Inductance
(c) Condenser
(d) Wire wound resistor

[SSC-JE : 2014 (AN)]

1.28 Two wires A and B have the same cross-section and are made of the same material. $R_A = 600 \Omega$ and $R_B = 100 \Omega$. The number of times A is longer than B is :

- (a) 5 (b) 6 (c) 2 (d) 4

[SSC-JE : 2014 (AN)]

1.29 Two 100 W , 200 V lamps are connected in series across a 200 V supply. The total power consumed by each lamp in watts will be

- (a) 200 (b) 25 (c) 50 (d) 100

[SSC-JE : 2014 (AN)]

1.30 A terminal where three or more branches meet is known as :

- (a) mesh (b) node
(c) terminus (d) loop

[SSC-JE : 2014 (AN)]

1.31 Total capacitance between the point L and M in figure is

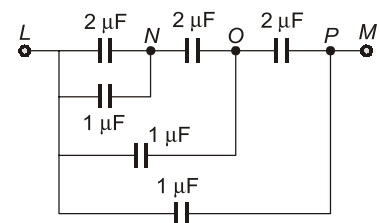

- (a) $4.05 \mu\text{F}$ (b) $1.45 \mu\text{F}$
(c) $1.85 \mu\text{F}$ (d) $2.05 \mu\text{F}$

[SSC-JE : 2014 (AN)]

1.32 Three resistors, each of ' R ' Ω are connected in star. What is the value of equivalent delta connected resistors?

- (a) $3R \Omega$
- (b) $\frac{R}{2} \Omega$
- (c) $2R \Omega$
- (d) $\frac{R}{3} \Omega$

[SSC-JE: 2014 (AN)]

1.33 Two electric bulbs have tungsten filament of same thickness. If one of them gives 60 W, and the other gives 100 W, then

- (a) 60 W and 100 W lamp filaments have equal length.
- (b) 60 W lamp filament has shorter length.
- (c) 100 W lamp filament has longer length.
- (d) 60 W lamp filament has longer length.

[SSC-JE: 2014 (AN)]

1.34 An ideal voltage source should have

- (a) infinite source resistance
- (b) large value of emf
- (c) small value of emf
- (d) zero source resistance

[SSC-JE: 2014 (AN)]

1.35 Find R_{AB} for the circuit shown in figure.

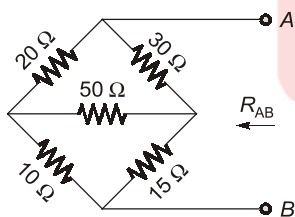

- (a) 18Ω
- (b) 30Ω
- (c) 45Ω
- (d) 68Ω

[SSC-JE: 2014 (FN)]

1.36 The R_{eq} for the circuit shown in figure is

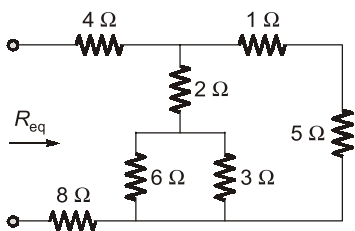

- (a) 14.4Ω
- (b) 14.57Ω
- (c) 15.27Ω
- (d) 15.88Ω

[SSC-JE: 2014 (FN)]

1.37 A circuit has inductance of 2 H. If the circuit current changes at the rate of 10 A/sec, then self-induced emf is

- (a) 5 V
- (b) 0.2 V
- (c) 20 V
- (d) 10 V

[SSC-JE: 2014 (FN)]

1.38 The reactance of 1 farad capacitance when connected to a DC circuit is

- (a) infinite
- (b) 1Ω
- (c) 0.5Ω
- (d) zero ohms

[SSC-JE: 2014 (FN)]

1.39 A capacitor with no initial charge at $t = \infty$ acts :

- (a) Open - Circuit
- (b) Voltage Source
- (c) Current Source
- (d) Short - Circuit

[SSC-JE: 2014 (AN)]

1.40 A current of 5 mA flows in a resistance less choke from a 200 V alternating source. The energy consumed in the choke is

- (a) 0 J
- (b) 4.4 J
- (c) 500 J
- (d) 1000 J

[SSC: 2014 (FN)]

1.41 The voltage across 5 H inductor is

$$v(t) = \begin{cases} 30t^2, & t > 0 \\ 0, & t < 0 \end{cases}$$

Find the energy stored at $t = 5$ s. Assume zero initial current.

- (a) 312.5 kJ
- (b) 0.625 kJ
- (c) 3.125 kJ
- (d) 156.25 kJ

[SSC-JE: 2014 (AN)]

1.42 If a $10 \mu\text{F}$ capacitor is connected to a voltage source with $v(t) = 50 \sin 2000t$ V, then the current through the capacitor is _____ A.

- (a) $10^6 \cos 2000 t$
- (b) $5 \times 10^{-4} \cos 2000 t$
- (c) $\cos 2000 t$
- (d) $500 \cos 2000 t$

[SSC-JE: 2014 (AN)]

1.43 An electric heater draws 3.5 A from a 110 V source. The resistance of the heating element is approximately?

- (a) 38.5 Ω
- (b) 385 Ω
- (c) 3.1 Ω
- (d) 31 Ω

[SSC-JE: 2015]

1.44 What will happen to the inductance, if number of turns of the coil is decreased?

- (a) Increase
- (b) Decrease
- (c) Remain same
- (d) None of these

[SSC-JE: 2015]

1.45 The rate of change of current in a 4 H inductor is 2 Amps/sec. Find the voltage across inductor.

- (a) 2 V
- (b) 0.8 V
- (c) 16 V
- (d) 8 V

[SSC-JE: 2015]

1.46 In a pure inductive circuit if the supply frequency is reduced to 1/2, the current will

- (a) be four times as high
- (b) be doubled
- (c) be reduced by half
- (d) be reduced to one fourth

[SSC-JE: 2015]

1.47 An active element in a circuit is one which :

- (a) receives energy
- (b) supplies energy
- (c) dissipates energy
- (d) both receives and supplies energy

[SSC-JE: 2015]

1.48 If two capacitances C_1 and C_2 are connected in parallel then the equivalent capacitance is given by :

- (a) $C_1 C_2$
- (b) C_2 / C_1
- (c) $C_1 + C_2$
- (d) C_1 / C_2

[SSC-JE: 2015]

1.49 A linear circuit is one whose parameters

- (a) do not change with voltage and current.
- (b) change with change in current.
- (c) change with change in voltage.
- (d) None of the options.

[SSC-JE: 2015]

1.50 For the circuit shown below, find the resistance between points P and Q.

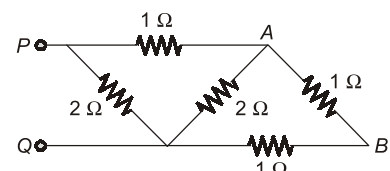

- (a) 2 Ω
- (b) 1 Ω
- (c) 3 Ω
- (d) 4 Ω

[SSC-JE: 2015]

Answers Electric Circuits and Magnetic Circuits**1. Basics**

1.1	(b)	1.2	(b)	1.3	(b)	1.4	(b)	1.5	(a)	1.6	(b)	1.7	(d)	1.8	(b)	1.9	(a)
1.10	(d)	1.11	(c)	1.12	(c)	1.13	(d)	1.14	(d)	1.15	(a)	1.16	(a)	1.17	(d)	1.18	(c)
1.19	(c)	1.20	(b)	1.21	(d)	1.22	(b)	1.23	(b)	1.24	(a)	1.25	(a)	1.26	(b)	1.27	(a)
1.28	(b)	1.29	(b)	1.30	(b)	1.31	(d)	1.32	(a)	1.33	(d)	1.34	(d)	1.35	(a)	1.36	(a)
1.37	(c)	1.38	(a)	1.39	(a)	1.40	(a)	1.41	(d)	1.42	(c)	1.43	(d)	1.44	(b)	1.45	(d)
1.46	(b)	1.47	(b)	1.48	(c)	1.49	(a)	1.50	(b)	1.51	(b)	1.52	(c)	1.53	(b)	1.54	(d)
1.55	(a)	1.56	(b)	1.57	(b)	1.58	(c)	1.59	(d)	1.60	(c)	1.61	(a)	1.62	(b)	1.63	(a)
1.64	(c)	1.65	(c)	1.66	(d)	1.67	(d)	1.68	(b)	1.69	(a)	1.70	(b)	1.71	(c)	1.72	(c)
1.73	(b)	1.74	(b)	1.75	(a)	1.76	(c)	1.77	(d)	1.78	(a)	1.79	(b)	1.80	(b)	1.81	(c)
1.82	(d)	1.83	(d)	1.84	(a)	1.85	(a)	1.86	(c)	1.87	(d)	1.88	(d)	1.89	(d)	1.90	(d)
1.91	(d)	1.92	(a)	1.93	(c)	1.94	(b)	1.95	(c)	1.96	(b)	1.97	(d)	1.98	(a)	1.99	(a)
1.100	(c)	1.101	(a)	1.102	(b)	1.103	(c)	1.104	(d)	1.105	(a)	1.106	(d)	1.107	(b)	1.108	(a)
1.109	(a)	1.110	(c)	1.111	(d)	1.112	(b)	1.113	(b)	1.114	(d)	1.115	(c)	1.116	(c)	1.117	(a)
1.118	(c)	1.119	(a)	1.120	(d)	1.121	(d)	1.122	(a)	1.123	(b)	1.124	(a)	1.125	(a)	1.126	(b)
1.127	(d)	1.128	(a)	1.129	(b)	1.130	(b)	1.131	(d)	1.132	(a)	1.133	(c)	1.134	(a)	1.135	(b)
1.136	(a)	1.137	(*)	1.138	(a)	1.139	(c)	1.140	(c)	1.141	(a)	1.142	(c)	1.143	(a)	1.144	(c)
1.145	(d)	1.146	(a)	1.147	(a)	1.148	(a)	1.149	(c)	1.150	(a)	1.151	(b)	1.152	(a)	1.153	(c)
1.154	(d)	1.155	(d)	1.156	(c)	1.157	(c)	1.158	(b)	1.159	(a)	1.160	(a)	1.161	(a)	1.162	(b)
1.163	(d)	1.164	(c)	1.165	(*)	1.166	(a)	1.167	(c)	1.168	(d)	1.169	(a)	1.170	(c)	1.171	(d)
1.172	(a)	1.173	(c)	1.174	(d)	1.175	(c)	1.176	(c)	1.177	(b)	1.178	(d)	1.179	(a)	1.180	(b)
1.181	(a)	1.182	(b)	1.183	(d)	1.184	(c)	1.185	(c)	1.186	(a)	1.187	(a)	1.188	(a)	1.189	(a)
1.190	(b)	1.191	(b)	1.192	(b)	1.193	(d)	1.194	(c)	1.195	(b)	1.196	(c)	1.197	(d)	1.198	(b)
1.199	(d)	1.200	(a)	1.201	(d)	1.202	(a)	1.203	(b)	1.204	(c)	1.205	(b)	1.206	(c)	1.207	(b)
1.208	(a)	1.209	(b)	1.210	(c)	1.211	(d)	1.212	(a)	1.213	(c)	1.214	(b)	1.215	(d)	1.216	(b)
1.217	(d)	1.218	(c)	1.219	(c)	1.220	(a)	1.221	(a)	1.222	(d)	1.223	(c)	1.224	(b)	1.225	(a)
1.226	(d)	1.227	(b)	1.228	(b)	1.229	(c)	1.230	(b)	1.231	(c)	1.232	(b)	1.233	(b)	1.234	(c)
1.235	(d)	1.236	(d)	1.237	(a)	1.238	(c)	1.239	(a)	1.240	(b)	1.241	(c)	1.242	(b)	1.243	(d)
1.244	(c)	1.245	(d)	1.246	(a)	1.247	(b)	1.248	(c)	1.249	(b)	1.250	(c)	1.251	(d)	1.252	(c)
1.253	(b)	1.254	(b)	1.255	(b)	1.256	(d)	1.257	(c)	1.258	(a)	1.259	(a)	1.260	(a)	1.261	(d)
1.262	(d)	1.263	(b)	1.264	(c)	1.265	(a)	1.266	(b)	1.267	(d)	1.268	(c)	1.269	(d)	1.270	(b)
1.271	(c)	1.272	(d)	1.273	(c)	1.274	(b)	1.275	(b)	1.276	(c)	1.277	(a)	1.278	(d)	1.279	(c)
1.280	(a)	1.281	(b)	1.282	(c)	1.283	(a)	1.284	(d)	1.285	(b)	1.286	(a)	1.287	(c)	1.288	(a)
1.289	(d)	1.290	(a)	1.291	(b)	1.292	(c)	1.293	(a)	1.294	(c)	1.295	(d)	1.296	(a)	1.297	(a)
1.298	(b)	1.299	(a)	1.300	(a)	1.301	(b)	1.302	(d)	1.303	(a)	1.304	(c)	1.305	(a)	1.306	(b)
1.307	(d)	1.308	(d)	1.309	(c)	1.310	(a)	1.311	(c)	1.312	(c)	1.313	(d)	1.314	(b)	1.315	(c)
1.316	(d)	1.317	(b)	1.318	(d)	1.319	(c)	1.320	(c)	1.321	(b)	1.322	(a)	1.323	(a)	1.324	(a)
1.325	(b)	1.326	(a)	1.327	(a)	1.328	(a)	1.329	(d)	1.330	(d)	1.331	(a)	1.332	(d)	1.333	(c)
1.334	(d)	1.335	(a)	1.336	(b)	1.337	(d)	1.338	(d)	1.339	(c)	1.340	(d)	1.341	(a)	1.342	(b)
1.343	(c)	1.344	(b)	1.345	(d)	1.346	(b)	1.347	(a)	1.348	(c)	1.349	(a)	1.350	(d)	1.351	(c)
1.352	(d)	1.353	(c)	1.354	(a)	1.355	(c)	1.356	(d)	1.357	(a)	1.358	(b)	1.359	(a)	1.360	(c)
1.361	(a)	1.362	(a)	1.363	(c)	1.364	(c)	1.365	(b)	1.366	(b)	1.367	(d)	1.368	(c)	1.369	(c)
1.370	(c)	1.371	(a)	1.372	(b)	1.373	(d)	1.374	(b)	1.375	(d)	1.376	(d)	1.377	(a)	1.378	(d)
1.379	(a)	1.380	(d)	1.381	(a)	1.382	(b)	1.383	(d)	1.384	(b)	1.385	(d)	1.386	(b)	1.387	(b)
1.388	(a)	1.389	(b)	1.390	(c)	1.391	(b)	1.392	(c)	1.393	(b)	1.394	(b)	1.395	(c)	1.396	(a)
1.397	(a)	1.398	(a)	1.399	(d)	1.400	(b)	1.401	(d)	1.402	(c)	1.403	(d)	1.404	(d)	1.405	(b)
1.406	(d)	1.407	(d)	1.408	(c)	1.409	(a)	1.410	(d)	1.411	(a)	1.412	(a)	1.413	(d)	1.414	(d)
1.415	(d)	1.416	(b)	1.417	(d)	1.418	(a)	1.419	(a)	1.420	(b)	1.421	(c)	1.422	(a)	1.423	(a)

1.424 (a) 1.425 (a) 1.426 (c) 1.427 (c) 1.428 (a) 1.429 (b) 1.430 (d) 1.431 (a) 1.432 (c)
 1.433 (a) 1.434 (c) 1.435 (b) 1.436 (d) 1.437 (c) 1.438 (b) 1.439 (a) 1.440 (a) 1.441 (b)
 1.442 (b) 1.443 (a)

2. Circuit Laws

2.1 (c) 2.2 (c) 2.3 (c) 2.4 (d) 2.5 (d) 2.6 (c) 2.7 (c) 2.8 (b) 2.9 (c)
 2.10 (b) 2.11 (*) 2.12 (d) 2.13 (c) 2.14 (c) 2.15 (b) 2.16 (a) 2.17 (b) 2.18 (b)
 2.19 (a) 2.20 (c) 2.21 (a) 2.22 (b) 2.23 (b) 2.24 (d) 2.25 (d) 2.26 (*) 2.27 (a)
 2.28 (b) 2.29 (d) 2.30 (a) 2.31 (a) 2.32 (c) 2.33 (a) 2.34 (d) 2.35 (*) 2.36 (c)
 2.37 (b) 2.38 (a) 2.39 (b) 2.40 (d) 2.41 (a) 2.42 (c) 2.43 (d) 2.44 (d) 2.45 (a)
 2.46 (a) 2.47 (d) 2.48 (c) 2.49 (c) 2.50 (b) 2.51 (a) 2.52 (a) 2.53 (c) 2.54 (a)
 2.55 (b) 2.56 (b) 2.57 (c) 2.58 (b) 2.59 (a) 2.60 (a) 2.61 (a) 2.62 (a) 2.63 (b)
 2.64 (b) 2.65 (a) 2.66 (c) 2.67 (b) 2.68 (c) 2.69 (b) 2.70 (a) 2.71 (c) 2.72 (c)
 2.73 (c) 2.74 (d) 2.75 (b) 2.76 (a) 2.77 (a) 2.78 (b) 2.79 (a) 2.80 (d) 2.81 (d)
 2.82 (d) 2.83 (b) 2.84 (d) 2.85 (a) 2.86 (d) 2.87 (b) 2.88 (c) 2.89 (b) 2.90 (a)
 2.91 (b) 2.92 (b) 2.93 (b) 2.94 (b) 2.95 (a) 2.96 (c) 2.97 (a) 2.98 (b) 2.99 (c)
 2.100 (c) 2.101 (c) 2.102 (c) 2.103 (a) 2.104 (d) 2.105 (d) 2.106 (b) 2.107 (b) 2.108 (a)
 2.109 (c) 2.110 (d) 2.111 (d) 2.112 (b) 2.113 (a) 2.114 (c) 2.115 (d) 2.116 (a) 2.117 (d)
 2.118 (b) 2.119 (d) 2.120 (c) 2.121 (d) 2.122 (d) 2.123 (d) 2.124 (a) 2.125 (d) 2.126 (b)
 2.127 (c) 2.128 (a)

3. AC Fundamentals & Transient Analysis

3.1. (c) 3.2. (b) 3.3. (a) 3.4 (d) 3.5 (b) 3.6 (d) 3.7 (a) 3.8 (d) 3.9 (d)
 3.10 (a) 3.11 (d) 3.12 (c) 3.13 (c) 3.14 (d) 3.15 (a) 3.16 (c) 3.17 (b) 3.18 (a)
 3.19 (c) 3.20 (b) 3.21 (d) 3.22 (b) 3.23 (d) 3.24 (c) 3.25 (a) 3.26 (c) 3.27 (d)
 3.28 (b) 3.29 (b) 3.30 (a) 3.31 (d) 3.32 (c) 3.33 (b) 3.34 (d) 3.35 (c) 3.36 (c)
 3.37 (a) 3.38 (c) 3.39 (b) 3.40 (a) 3.41 (a) 3.42 (d) 3.43 (c) 3.44 (d) 3.45 (a)
 3.46 (d) 3.47 (d) 3.48 (d) 3.49 (d) 3.50 (c) 3.51 (b) 3.52 (a) 3.53 (d) 3.54 (a)
 3.55 (c) 3.56 (a) 3.57 (b) 3.58 (c) 3.59 (a) 3.60 (c) 3.61 (b) 3.62 (c) 3.63 (d)
 3.64 (c) 3.65 (c) 3.66 (b) 3.67 (c) 3.68 (c) 3.69 (a) 3.70 (a) 3.71 (a) 3.72 (c)
 3.73 (b) 3.74 (b) 3.75 (a) 3.76 (d) 3.77 (b) 3.78 (b) 3.79 (b) 3.80 (a) 3.81 (d)
 3.82 (b) 3.83 (d) 3.84 (c) 3.85 (c) 3.86 (a) 3.87 (d) 3.88 (b) 3.89 (c) 3.90 (b)
 3.91 (a) 3.92 (d) 3.93 (c) 3.94 (a) 3.95 (a) 3.96 (b) 3.97 (a) 3.98 (a) 3.99 (c)
 3.100 (b) 3.101 (a) 3.102 (a) 3.103 (d) 3.104 (c) 3.105 (b) 3.106 (a) 3.107 (a) 3.108 (d)
 3.109 (c) 3.110 (b) 3.111 (d) 3.112 (c) 3.113 (a) 3.114 (b) 3.115 (a) 3.116 (a) 3.117 (a)
 3.118 (a) 3.119 (b) 3.120 (c) 3.121 (b) 3.122 (a) 3.123 (c) 3.124 (a) 3.125 (b) 3.126 (b)
 3.127 (a) 3.128 (b) 3.129 (a) 3.130 (c) 3.131 (a) 3.132 (b) 3.133 (b) 3.134 (b) 3.135 (c)
 3.136 (b) 3.137 (b) 3.138 (c) 3.139 (d) 3.140 (c) 3.141 (c) 3.142 (d) 3.143 (a) 3.144 (c)
 3.145 (d) 3.146 (a) 3.147 (d) 3.148 (a) 3.149 (d) 3.150 (a) 3.151 (c) 3.152 (d) 3.153 (a)
 3.154 (a) 3.155 (b) 3.156 (c) 3.157 (b) 3.158 (c) 3.159 (a) 3.160 (b) 3.161 (a) 3.162 (d)
 3.163 (c) 3.164 (b) 3.165 (b) 3.166 (d) 3.167 (d) 3.168 (c) 3.169 (d) 3.170 (a) 3.171 (c)
 3.172 (a) 3.173 (b) 3.174 (c) 3.175 (b) 3.176 (b) 3.177 (d) 3.178 (a) 3.179 (d) 3.180 (d)
 3.181 (d) 3.182 (b) 3.183 (b) 3.184 (b) 3.185 (d) 3.186 (d) 3.187 (d) 3.188 (*) 3.189 (b)
 3.190 (b) 3.191 (b) 3.192 (c) 3.193 (c) 3.194 (b) 3.195 (a) 3.196 (a) 3.197. (d) 3.198 (a)
 3.199 (b) 3.200 (b) 3.201 (b) 3.202 (c) 3.203 (d) 3.204 (c) 3.205 (a) 3.206 (a) 3.207 (c)
 3.208 (d) 3.209 (d) 3.210 (a) 3.211 (d) 3.212 (d) 3.213 (b) 3.214 (b) 3.215 (c) 3.216 (c)
 3.217 (d) 3.218 (c) 3.219 (c) 3.220 (d) 3.221 (d) 3.222 (b) 3.223 (b) 3.224 (a) 3.225 (c)
 3.226 (a) 3.227 (c) 3.228 (d) 3.229 (a) 3.230 (c) 3.231 (c) 3.232 (a) 3.233 (d) 3.234 (d)
 3.235 (a) 3.236 (b) 3.237 (a) 3.238 (d) 3.239 (b) 3.240 (c) 3.241 (d) 3.242 (b) 3.243 (a)
 3.244 (d) 3.245 (d) 3.246 (d) 3.247 (d) 3.248 (a) 3.249 (d) 3.250 (d) 3.251 (d) 3.252 (b)

3.253 (b)	3.254 (b)	3.255 (a)	3.256 (a)	3.257 (c)	3.258 (c)	3.259 (c)	3.260 (c)	3.261 (b)
3.262 (d)	3.263 (b)	3.264 (d)	3.265 (d)	3.266 (d)	3.267 (c)	3.268 (d)	3.269 (b)	3.270 (a)
3.271 (a)	3.272 (b)	3.273 (b)	3.274 (c)	3.275 (c)	3.276 (b)	3.277 (c)	3.278 (b)	3.279 (a)
3.280 (c)	3.281 (c)	3.282 (d)	3.283 (d)	3.284 (b)	3.285 (c)	3.286 (c)	3.287 (c)	3.288 (b)
3.289 (c)	3.290 (c)	3.291 (c)	3.292 (d)	3.293 (b)				

4. Network Theorems

4.1 (b)	4.2 (b)	4.3 (a)	4.4 (c)	4.5 (d)	4.6 (b)	4.7 (a)	4.8 (a)	4.9 (b)
4.10 (b)	4.11 (b)	4.12 (c)	4.13 (d)	4.14 (b)	4.15 (c)	4.16 (d)	4.17 (c)	4.18 (c)
4.19 (c)	4.20 (*)	4.21 (c)	4.22 (a)	4.23 (b)	4.24 (a)	4.25 (c)	4.26 (a)	4.27 (*)
4.28 (d)	4.29 (a)	4.30 (c)	4.31 (c)	4.32 (d)	4.33 (b)	4.34 (a)	4.35 (a)	4.36 (b)
4.37 (b)	4.38 (b)	4.39 (c)	4.40 (b)	4.41 (b)	4.42 (b)	4.43 (b)	4.44 (c)	4.45 (c)
4.46 (d)	4.47 (a)	4.48 (b)	4.49 (d)	4.50 (c)	4.51 (d)	4.52 (c)	4.53 (c)	4.54 (d)
4.55 (a)	4.56 (d)	4.57 (d)	4.58 (b)	4.59 (c)	4.60 (a)	4.61 (b)	4.62 (c)	4.63 (c)
4.64 (d)	4.65 (b)	4.66 (c)	4.67 (a)	4.68 (d)	4.69 (d)	4.70 (b)	4.71 (c)	4.72 (a)
4.73 (b)	4.74 (c)	4.75 (c)	4.76 (b)	4.77 (b)	4.78 (d)	4.79 (d)	4.80 (a)	4.81 (a)
4.82 (c)	4.83 (c)	4.84 (d)	4.85 (c)	4.86 (d)	4.87 (c)	4.88 (c)	4.89 (c)	4.90 (d)
4.91 (c)	4.92 (c)	4.93 (c)	4.94 (b)	4.95 (b)	4.96 (b)	4.97 (c)	4.98 (c)	4.99 (d)
4.100 (d)	4.101 (c)	4.102 (c)	4.103 (c)	4.104 (b)	4.105 (b)	4.106 (b)	4.107 (b)	4.108 (c)
4.109 (a)	4.110 (a)	4.111 (b)	4.112 (d)	4.113 (c)	4.114 (a)	4.115 (a)	4.116 (d)	4.117 (b)
4.118 (b)	4.119 (b)	4.120 (a)	4.121 (b)	4.122 (b)				

5. Resonance & Magnetically Coupled Circuits

5.1 (b)	5.2 (c)	5.3 (c)	5.4 (b)	5.5 (b)	5.6 (c)	5.7 (c)	5.8 (d)	5.9 (b)
5.10 (a)	5.11 (b)	5.12 (a)	5.13 (c)	5.14 (b)	5.15 (c)	5.16 (b)	5.17 (d)	5.18 (a)
5.19 (d)	5.20 (a)	5.21 (b)	5.22 (b)	5.23 (c)	5.24 (d)	5.25 (c)	5.26 (c)	5.27 (a)
5.28 (b)	5.29 (a)	5.30 (a)	5.31 (a)	5.32 (a)	5.33 (b)	5.34 (b)	5.35 (b)	5.36 (c)
5.37 (a)	5.38 (a)	5.39 (c)	5.40 (*)	5.41 (d)	5.42 (a)	5.43 (b)	5.44 (c)	5.45 (c)
5.46 (a)	5.47 (a)	5.48 (c)	5.49 (d)	5.50 (c)	5.51 (b)	5.52 (c)	5.53 (d)	5.54 (b)
5.55 (*)	5.56 (a)	5.57 (d)	5.58 (b)	5.59 (c)	5.60 (d)	5.61 (a)	5.62 (*)	5.63 (a)
5.64 (a)	5.65 (a)	5.66 (c)	5.67 (c)	5.68 (b)	5.69 (d)	5.70 (c)	5.71 (a)	5.72 (c)
5.73 (c)	5.74 (d)	5.75 (a)	5.76 (b)	5.77 (d)	5.78 (c)	5.79 (b)	5.80 (a)	5.81 (c)
5.82 (c)	5.83 (b)	5.84 (a)	5.85 (a)	5.86 (c)	5.87 (b)	5.88 (a)	5.89 (b)	5.90 (d)
5.91 (c)	5.92 (a)	5.93 (a)	5.94 (a)	5.95 (d)	5.96 (a)	5.97 (c)	5.98 (c)	5.99 (b)
5.100 (c)	5.101 (a)	5.102 (d)	5.103 (a)	5.104 (a)	5.105 (d)	5.106 (d)	5.107 (c)	5.108 (d)

6. Three Phase Systems

6.1 (d)	6.2 (a)	6.3 (b)	6.4 (c)	6.5 (c)	6.6 (d)	6.7 (c)	6.8 (d)	6.9 (d)
6.10 (b)	6.11 (b)	6.12 (d)	6.13 (d)	6.14 (c)	6.15 (d)	6.16 (b)	6.17 (a)	6.18 (a)
6.19 (d)	6.20 (c)	6.21 (d)	6.22 (a)	6.23 (c)	6.24 (b)	6.25 (b)	6.26 (a)	6.27 (a)
6.28 (a)	6.29 (d)	6.30 (d)	6.31 (c)	6.32 (c)	6.33 (d)	6.34 (d)	6.35 (b)	6.36 (d)
6.37 (c)	6.38 (a)	6.39 (b)	6.40 (d)	6.41 (c)	6.42 (b)	6.43 (c)	6.44 (c)	6.45 (a)
6.46 (b)	6.47 (a)	6.48 (b)	6.49 (c)	6.50 (a)	6.51 (d)	6.52 (a)	6.53 (d)	6.54 (b)
6.55 (b)	6.56 (a)	6.57 (a)						

7. Magnetic Circuits

7.1 (a)	7.2 (a)	7.3 (c)	7.4 (d)	7.5 (d)	7.6 (b)	7.7 (d)	7.8 (c)	7.9 (b)
7.10 (c)	7.11 (d)	7.12 (b)	7.13 (d)	7.14 (b)	7.15 (a)	7.16 (a)	7.17 (c)	7.18 (a)
7.19 (c)	7.20 (b)	7.21 (c)	7.22 (d)	7.23 (a)	7.24 (b)	7.25 (d)	7.26 (b)	7.27 (c)

7.28 (b)	7.29 (c)	7.30 (b)	7.31 (a)	7.32 (c)	7.33 (b)	7.34 (c)	7.35 (b)	7.36 (c)
7.37 (b)	7.38 (b)	7.39 (c)	7.40 (b)	7.41 (a)	7.42 (b)	7.43 (c)	7.44 (b)	7.45 (b)
7.46 (c)	7.47 (c)	7.48 (b)	7.49 (a)	7.50 (a)	7.51 (d)	7.52 (a)	7.53 (c)	7.54 (d)
7.55 (a)	7.56 (d)	7.57 (c)	7.58 (a)	7.59 (d)	7.60 (b)	7.61 (a)	7.62 (b)	7.63 (c)
7.64 (b)	7.65 (d)	7.66 (a)	7.67 (c)	7.68 (b)	7.69 (a)	7.70 (c)	7.71 (c)	7.72 (d)
7.73 (c)	7.74 (d)	7.75 (c)	7.76 (a)	7.77 (d)	7.78 (a)	7.79 (d)	7.80 (b)	7.81 (a)
7.82 (b)	7.83 (a)	7.84 (c)	7.85 (d)	7.86 (c)	7.87 (d)	7.88 (a)	7.89 (b)	7.90 (d)
7.91 (d)	7.92 (b)	7.93 (c)	7.94 (d)	7.95 (b)	7.96 (a)	7.97 (d)	7.98 (b)	7.99 (c)
7.100 (b)	7.101 (a)	7.102 (d)	7.103 (a)	7.104 (a)	7.105 (b)	7.106 (c)	7.107 (d)	7.108 (d)
7.109 (a)	7.110 (b)	7.111 (d)	7.112 (c)	7.113 (c)	7.114 (c)	7.115 (d)	7.116 (b)	7.117 (c)
7.118 (a)	7.119 (d)	7.120 (a)	7.121 (d)	7.122 (d)	7.123 (b)	7.124 (a)	7.125 (a)	7.126 (b)
7.127 (a)	7.128 (d)	7.129 (b)	7.130 (c)	7.131 (c)	7.132 (b)	7.133 (a)	7.134 (a)	7.135 (c)
7.136 (c)	7.137 (c)	7.138 (d)	7.139 (a)	7.140 (d)	7.141 (d)	7.142 (a)	7.143 (d)	7.144 (b)
7.145 (a)	7.146 (d)	7.147 (b)	7.148 (a)	7.149 (a)	7.150 (c)	7.151 (d)	7.152 (b)	7.153 (b)
7.154 (d)	7.155 (c)	7.156 (a)	7.157 (b)	7.158 (b)	7.159 (a)	7.160 (a)	7.161 (d)	7.162 (b)
7.163 (a)	7.164 (d)	7.165 (b)	7.166 (c)	7.167 (a)	7.168 (b)	7.169 (c)	7.170 (d)	7.171 (b)
7.172 (c)	7.173 (a)	7.174 (a)	7.175 (b)	7.176 (a)	7.177 (a)	7.178 (c)	7.179 (d)	7.180 (c)
7.181 (a)	7.182 (b)	7.183 (c)	7.184 (c)	7.185 (b)	7.186 (d)	7.187 (b)	7.188 (c)	7.189 (d)
7.190 (*)	7.191 (a)	7.192 (a)	7.193 (a)	7.194 (c)	7.195 (c)	7.196 (d)	7.197 (c)	7.198 (b)
7.199 (d)	7.200 (d)	7.201 (b)	7.202 (a)	7.203 (a)	7.204 (b)	7.205 (*)	7.206 (a)	7.207 (c)
7.208 (a)	7.209 (d)	7.210 (a)	7.211 (b)	7.212 (d)	7.213 (b)	7.214 (a)	7.215 (d)	7.216 (d)
7.217 (a)	7.218 (c)	7.219 (a)	7.220 (d)	7.221 (a)	7.222 (a)	7.223 (a)	7.224 (c)	7.225 (b)
7.226 (b)	7.227 (d)	7.228 (c)	7.229 (d)	7.230 (d)	7.231 (c)	7.232 (b)	7.233 (b)	7.234 (c)
7.235 (b)	7.236 (a)	7.237 (b)	7.238 (d)	7.239 (b)	7.240 (a)	7.241 (a)	7.242 (b)	7.243 (b)
7.244 (c)	7.245 (c)	7.246 (d)	7.247 (a)	7.248 (c)	7.249 (c)	7.250 (b)	7.251 (d)	7.252 (b)
7.253 (d)	7.254 (b)	7.255 (d)	7.256 (a)	7.257 (b)	7.258 (c)	7.259 (b)	7.260 (b)	7.261 (a)
7.262 (b)	7.263 (a)	7.264 (a)	7.265 (d)	7.266 (d)	7.267 (a)	7.268 (b)	7.269 (b)	7.270 (a)
7.271 (a)	7.272 (c)	7.273 (b)	7.274 (c)	7.275 (d)	7.276 (a)	7.277 (b)	7.278 (b)	7.279 (d)
7.280 (c)	7.281 (a)	7.282 (b)	7.283 (a)	7.284 (b)	7.285 (b)	7.286 (c)	7.287 (b)	7.288 (d)
7.289 (a)	7.290 (a)	7.291 (b)	7.292 (b)	7.293 (d)	7.294 (a)	7.295 (b)	7.296 (d)	7.297 (c)
7.298 (a)	7.299 (a)	7.300 (d)	7.301 (c)	7.302 (b)	7.303 (d)	7.304 (a)	7.305 (a)	7.306 (c)
7.307 (a)	7.308 (c)	7.309 (b)	7.310 (b)	7.311 (a)	7.312 (d)	7.313 (c)	7.314 (b)	7.315 (c)
7.316 (a)	7.317 (c)	7.318 (a)	7.319 (b)	7.320 (c)	7.321 (b)	7.322 (c)	7.323 (c)	7.324 (a)
7.325 (b)	7.326 (d)	7.327 (d)	7.328 (a)					

8. Miscellaneous

8.1 (a)	8.2 (d)	8.3 (a)	8.4 (c)	8.5 (b)	8.6 (a)	8.7 (a)	8.8 (d)	8.9 (d)
8.10 (c)	8.11 (b)	8.12 (b)	8.13 (d)	8.14 (b)	8.15 (c)	8.16 (a)	8.17 (b)	8.18 (d)
8.19 (c)	8.20 (b)	8.21 (d)	8.22 (b)	8.23 (c)	8.24 (b)	8.25 (b)	8.26 (a)	8.27 (d)
8.28 (d)	8.29 (c)	8.30 (c)	8.31 (b)	8.32 (c)	8.33 (c)	8.34 (a)	8.35 (c)	8.36 (d)
8.37 (c)	8.38 (a)	8.39 (c)	8.40 (c)	8.41 (b)	8.42 (b)	8.43 (b)	8.44 (c)	8.45 (a)
8.46 (d)	8.47 (d)	8.48 (a)	8.49 (d)	8.50 (a)	8.51 (c)	8.52 (a)	8.53 (d)	8.54 (d)
8.55 (b)	8.56 (a)	8.57 (b)	8.58 (b)	8.59 (a)	8.60 (a)	8.61 (a)	8.62 (a)	8.63 (b)
8.64 (c)	8.65 (a)	8.66 (b)	8.67 (d)	8.68 (b)	8.69 (b)	8.70 (d)	8.71 (b)	8.72 (b)
8.73 (a)	8.74 (a)	8.75 (b)	8.76 (a)	8.77 (d)	8.78 (b)	8.79 (a)	8.80 (a)	8.81 (c)
8.82 (b)	8.83 (a)	8.84 (c)	8.85 (a)	8.86 (b)	8.87 (d)	8.88 (b)	8.89 (d)	8.90 (b)
8.91 (d)	8.92 (c)	8.93 (c)	8.94 (c)	8.95 (a)	8.96 (d)	8.97 (b)	8.98 (b)	8.99 (a)
8.100 (c)	8.101 (c)	8.102 (c)	8.103 (c)	8.104 (c)	8.105 (b)			



Explanations Electric Circuits and Magnetic Circuits

1. Basics

1.1 (b)

- Capacitor is a device that opposes the sudden change in voltage i.e. it opposes dV/dt across it.
- It is not possible to change the voltage across a capacitor by a finite amount in zero time, as this requires an infinite current through the capacitor.

1.2 (b) The heaters of 1000 W, 250 V will have the resistance of

$$R = \frac{V^2}{P} = \frac{(250)^2}{1000} = 62.5 \Omega$$

So, equivalent circuit will be as shown below .

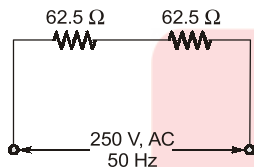

∴ $R_{eq} = 62.5 + 62.5 = 125 \Omega$

∴ $P = \frac{V^2}{R_{eq}} = \frac{(250)^2}{125} = 500 \text{ W}$

1.3 (b) Specific resistance 'ρ' of a material is a property of that material which depends only upon temperature and the composition of material. However, the resistance depends on length, area, temperature.

Resistance, $R \propto \frac{l}{A}$

or, $R = \frac{\rho l}{A}$ (ρ = specific resistance)

where, 'ρ' is constant for constant temperature.

1.4 (b) As the wire is stretched, the area will decrease and the length will increase but the net conductor volume will remain same.

Since, volumes are equal, therefore

$$A_1 l_1 = A_2 l_2 \quad \dots(i)$$

If $l_1 = l$, then $l_2 = l + \frac{1}{10}$ th of l

so, $l_2 = \frac{11l}{10}$

∴ $\frac{l_1}{l_2} = \frac{l}{\frac{11l}{10}} = \frac{10}{11}$

Now from equation (i),

$$\frac{l_1}{l_2} = \frac{A_2}{A_1} = \frac{10}{11}$$

Given : $R_1 = 10 \Omega$

Now, from $R = \frac{\rho l}{A}$ we have,

$$\frac{R_1}{R_2} = \frac{l_1}{l_2} \times \frac{A_2}{A_1}$$

or,

$$\frac{R_1}{R_2} = \frac{100}{121}$$

or,

$$R_2 = \frac{121R_1}{100} = \frac{121 \times 10}{100} = 12.1 \Omega$$

1.5 (a) Given :

$$P_1 = 100 \text{ W}, V_1 = 220 \text{ V}$$

$$P_2 = 100 \text{ W}, V_2 = 110 \text{ V}$$

Now,

$$R_1 = \frac{V_1^2}{P_1} = \frac{(220)^2}{100} = 484 \Omega$$

Also,

$$R_2 = \frac{V_2^2}{P_2} = \frac{(110)^2}{100} = 121 \Omega$$

∴

$$\frac{R_1}{R_2} = \frac{484}{121} = \frac{4}{1} = 4$$

1.6 (b) The equivalent capacitance for parallel connection is equal to sum of the individual capacitance.

∴ $C_{eq} = C_1 + C_2 + C_3 + C_4$

$$C_{eq} = 4 \times C = 4 \times 10 \mu\text{F}$$

$$C_{eq} = 40 \mu\text{F}$$

(for parallel connection)

Note : For series connection,

$$\frac{1}{C_{eq}} = \frac{1}{C_1} + \frac{1}{C_2} + \frac{1}{C_3} + \frac{1}{C_4}$$

1.7 (d) Given, in star connection,

$$R_{AN} = R_{BN} = R_{CN} = 5 \Omega = R_Y \text{ (Say)}$$

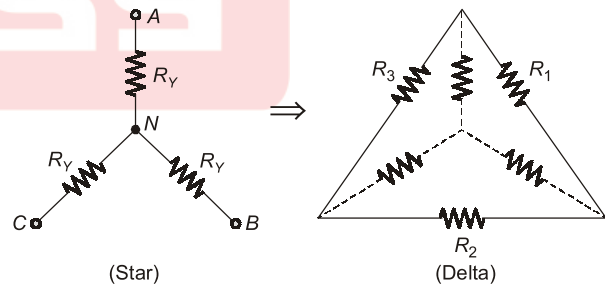

$$R_1 = \frac{R_{AN}R_{BN} + R_{BN}R_{CN} + R_{CN}R_{AN}}{R_{CN}}$$

$$R_2 = \frac{R_{AN}R_{BN} + R_{BN}R_{CN} + R_{CN}R_{AN}}{R_{AN}}$$

$$R_3 = \frac{R_{AN}R_{BN} + R_{BN}R_{CN} + R_{CN}R_{AN}}{R_{BN}}$$

Here as all resistance equal in value.

Hence,

$$R_1 = R_2 = R_3 = \frac{5 \times 5 + 5 \times 5 + 5 \times 5}{5} = 15 \Omega$$

Note : Also we can find directly using,

$$R_Y = \frac{R_D}{3} \text{ (for equal value of resistance)}$$

1.8 (b) Aluminium is conductor so, it has positive temperature coefficient of resistance.
Carbon is a semiconductor so, it has negative temperature coefficient of resistance.
Manganin is conductor but its temperature coefficient of resistance is negligible.

1.9 (a)

- Insulators and semiconductors have negative temperature coefficient of resistance. Hence with increase in temperature rise, resistance will decrease,

$$R_t = R_0(1 + \alpha\Delta T)$$
 where, α = temperature coefficient of resistance.
- If α is negative, R (resistance) will decrease as $T \uparrow$.

1.10 (d) Resistivity is the resistance per unit length and cross-sectional area. A low resistivity indicates a material that readily allows electric current.

At 20°C , resistivity of material (in Ωm) is

- (a) Iron $\rightarrow 1 \times 10^{-7} \Omega\text{m}$
- (b) Manganin $\rightarrow 4.2 \times 10^{-7} \Omega\text{m}$
- (c) Aluminium $\rightarrow 2.8 \times 10^{-8} \Omega\text{m}$
- (d) Copper $\rightarrow 1.7 \times 10^{-8} \Omega\text{m}$

Hence, copper has least resistivity.

1.11 (c) As the wires are of same material, therefore specific resistance of both the wires A and B will be same (Because specific resistance depends only on type of materials or composition).

1.12 (c)

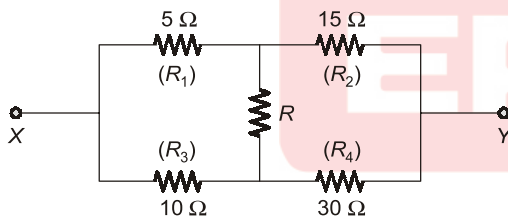

Above circuit is a balanced Wheatstone bridge, Hence, no current flows through the resistance R since arms ratio is constant.

$$\begin{aligned} \text{i.e., } \frac{R_1}{R_3} &= \frac{R_2}{R_4} \\ \frac{5}{10} &= \frac{15}{30} = \frac{1}{2} = \text{constant} \end{aligned}$$

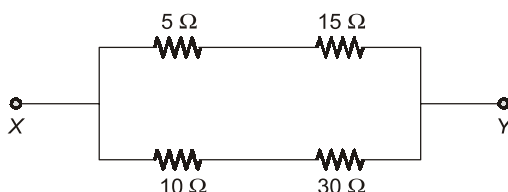

$$\begin{aligned} \therefore R_{xy} &= (5 + 15) \parallel (10 + 30) = 20 \parallel 40 \\ &= \frac{20 \times 40}{20 + 40} = \frac{40}{3} \Omega \end{aligned}$$

1.13 (d) We know that,

$$V = \frac{Q}{C}, \text{ i.e., } V \propto \frac{1}{C}$$

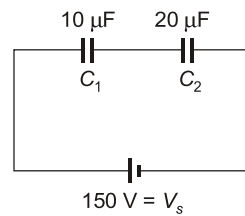

According to voltage divider rule,

$$\begin{aligned} V_{C_2} &= \frac{VC_1}{C_1 + C_2} \\ V_{20\mu\text{F}} &= \frac{10\mu\text{F}}{10\mu\text{F} + 20\mu\text{F}} \times 150 \\ &= 50 \text{ V} \end{aligned}$$

(In series charge is same and voltage divides).

1.14 (d) Voltage across an inductor is created to current by the equation,

$$V_L = L \frac{di_L}{dt}$$

As current is ramp function of finite duration, hence its differentiation leads to a step function of finite duration. Hence option (d) is correct.

1.15 (a) When capacitor is connected across an ideal voltage source, initially it is short circuited, hence current will be very high, and then it charges to voltage equal to value of voltage source. Hence current will decay exponentially and at steady state will become zero (since capacitor will acts as open-circuit in steady state).

1.16 (a)

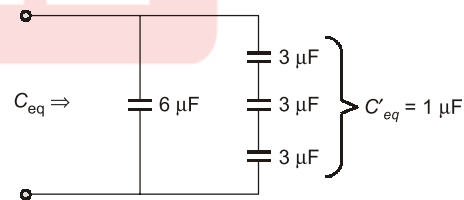

Let,

$$\begin{aligned} C_1 = C_2 = C_3 &= 3 \mu\text{F} \\ \frac{1}{C'_{eq}} &= \frac{1}{C_1} + \frac{1}{C_2} + \frac{1}{C_3} \text{ (for series connection)} \end{aligned}$$

$$\frac{1}{C'_{eq}} = \frac{3}{C_1}$$

$$\Rightarrow C'_{eq} = \frac{3\mu\text{F}}{3} = 1\mu\text{F}$$

Equivalent capacitance of three $3 \mu\text{F}$ capacitors is

$$\begin{aligned} \therefore C'_{eq} &= 1\mu\text{F} \\ C_{eq} &= 6\mu\text{F} + 1\mu\text{F} \text{ } (\because \text{in parallel}) \\ \text{or, } C_{eq} &= 7\mu\text{F} \end{aligned}$$

1.17 (d) Current through the capacitor is

$$i = C \frac{dV}{dt}$$

$$i = 2 \cdot \frac{dV}{dt}$$

The input voltage applied across the capacitor is shown below.

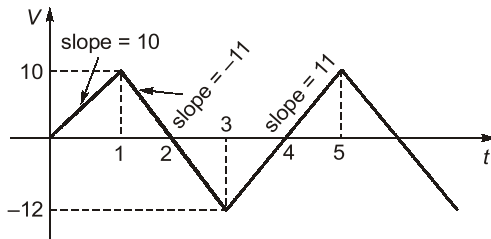

∴ $i = C \frac{dV}{dt} = 2 \frac{dV}{dt}$

The waveform for dV/dt is shown below.

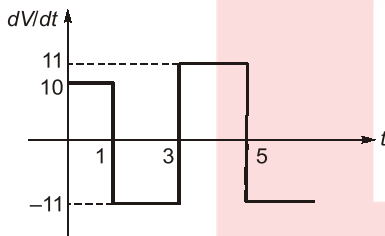

The waveform for current is shown below.

(Using, $i = 2 \frac{dV}{dt}$)

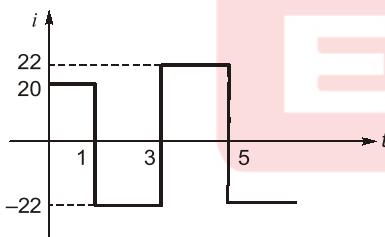

1.18 (c) Ampere-sec is the unit of electric charge.

Current, $i = \frac{Q}{t}$

or $Q = it$
 Thus, $[Q] = [i] [t]$
 ∴ $= A \cdot s$

Hence, unit of electric charge = A-sec

1.19 (c) Three inductors connected in delta as shown :

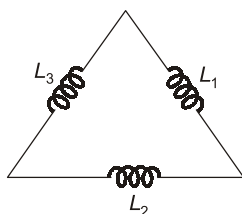

Given : $L_1 = L_2 = L_3 = 60 \text{ mH}$

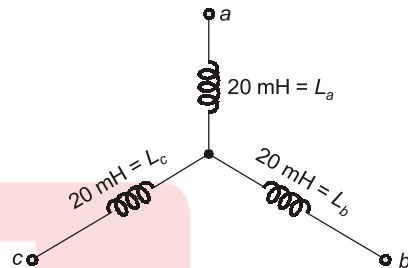
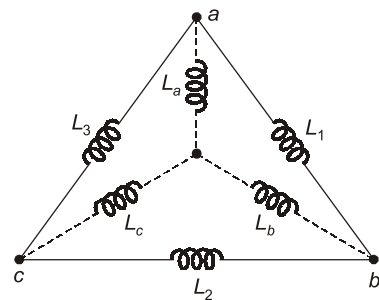

$$L_a = \frac{L_1 L_3}{L_1 + L_2 + L_3}$$

Clearly, Hence,

$$L_a = L_b = L_c$$

$$L_a = L_b = L_c = \frac{60 \times 60}{60 + 60 + 60} = \frac{3600}{180} = 20 \text{ mH}$$

1.20 (b)

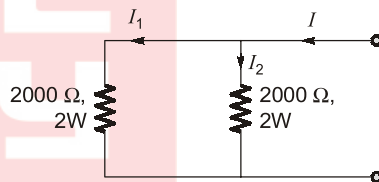

Equivalent resistance,

$$R_{eq} = R_1 \parallel R_2 \text{ (Parallel connection)}$$

$$= 2000 \parallel 2000$$

$$= \frac{2000 \times 2000}{2000 + 2000} = 1000 \Omega$$

Also, $P_1 = 2 \text{ W} = I_1^2 \cdot R_1$
 $= (I_1)^2 \times 2000$

or, $I_1^2 = \frac{1}{1000}$

Since, applied voltage is same across both resistors, therefore

$$I_1 = \frac{1}{\sqrt{1000}} \text{ A} = I_2$$

∴ $I = I_1 + I_2 = \frac{2}{\sqrt{1000}} \text{ A}$

∴ $P = I^2 \cdot R_{eq} = \frac{4}{1000} \times 1000$
 $= 4 \text{ W}$

1.21 (d) Given : $R_1 = 1 \Omega$, $R_2 = 2 \Omega$, $R_3 = 3 \Omega$

8 possible connections :

(i) In series :

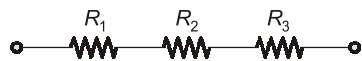

(ii) In parallel :

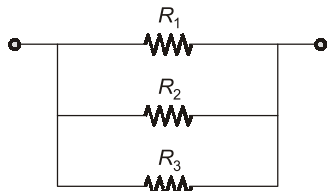

(iii) Combination-1:

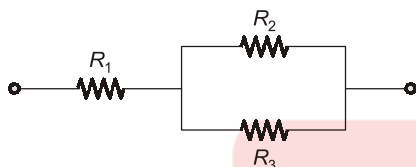

(iv) Combination-1:

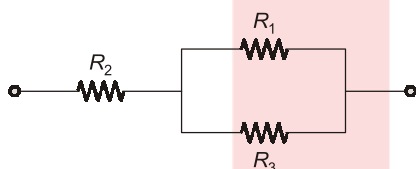

(v) Combination-1:

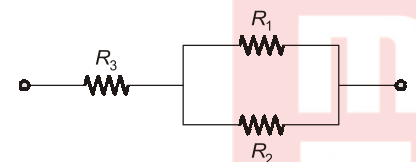

(vi) Combination-2:

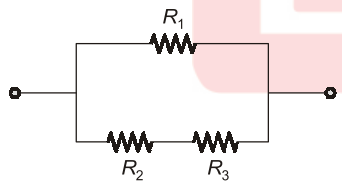

(vii) Combination-2:

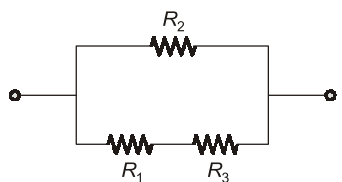

(viii) Combination-2:

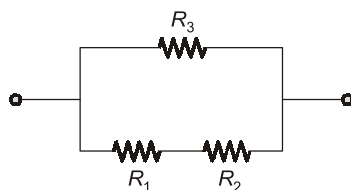

1.22 (b) Given : $V_1 = 250 \text{ V}$ and power drawn,

$$P_1 = 1000 \text{ W} = \frac{(250)^2}{R} \quad \left[\because P = \frac{V^2}{R} \right]$$

or,

$$R = \frac{250 \times 250}{1000} = \frac{125}{2} = 62.5 \Omega$$

= Heater resistance

Now,

$$V_2 = 200 \text{ Volts}$$

\therefore Power drawn from 200 V voltage source

$$P_2 = \frac{V_2^2}{R} = \frac{200 \times 200}{62.5} = 640 \text{ W}$$

1.23 (b)

- $R = \frac{\rho l}{A}$, i.e., for a fixed cross-section of wire, to get high resistance for minimum length of wire, ρ must be high.
- Low temperature coefficient of resistance shows low variation in resistance as the temperature varies.

1.24 (a) For parallel connection,

$$\frac{1}{R_{eq}} = \frac{1}{R_1} + \frac{1}{R_2} + \frac{1}{R_3} + \dots + \frac{1}{R_N}$$

Hence,

$$\frac{1}{R_{eq}} = \frac{1}{2} + \frac{1}{4} + \frac{1}{5} + \frac{1}{20}$$

or,

$$\frac{1}{R_{eq}} = \frac{10+5+4+1}{20}$$

$$\Rightarrow R_{eq} = \frac{20}{20} = 1 \Omega$$

1.25 (a)

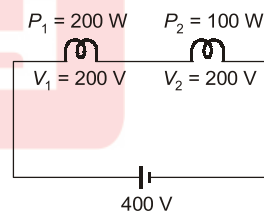

Here,

$$R_1 = \frac{V_1^2}{P_1} = \frac{200 \times 200}{200} = 200 \Omega$$

$$R_2 = \frac{V_2^2}{P_2} = \frac{200 \times 200}{100} = 400 \Omega$$

In series connection current is same and power = $I^2 R$

$$P_1 = I^2 R_1 \text{ and } P_2 = I^2 R_2$$

As resistance of 2nd bulb (100 W, 200 V) is more hence it draws more power and glows brighter.

1.26 (b)

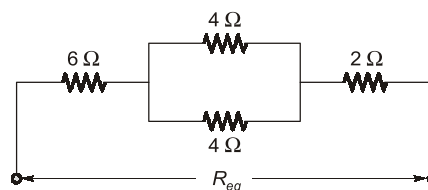

If $4\ \Omega$ is not disconnected,

$$R_{eq} = 6 + (4 \parallel 4) + 2$$

$$= 6 + \frac{4 \times 4}{4 + 4} + 2 = 10\ \Omega$$

If one $4\ \Omega$ is disconnected,

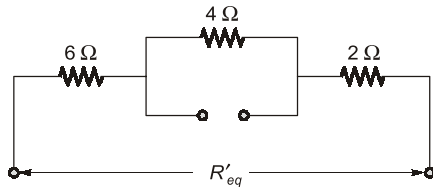

$$R'_{eq} = 6 + 4 + 2 = 12\ \Omega$$

As equivalent resistance is increasing after disconnecting $4\ \Omega$ resistance, hence current decreases as $\{I \propto 1/R\}$ for constant V .

1.27 (a) Linear circuit parameters of the linear circuit are resistance, capacitance (condenser), inductance are constant, i.e., not changed with respect to voltage and current unlike non-linear elements that does not have any linear relationship between current and voltage, some of non-linear elements are diode, transformer transistor, etc.

1.28 (b) Given : $R_A = 600\ \Omega$; $R_B = 100\ \Omega$

Resistance, $R = \frac{\rho l}{A}$

As ρ and A are same as same material and given that area is same also,

$$\therefore R \propto l$$

$$\Rightarrow \frac{R_A}{R_B} = \frac{l_A}{l_B}$$

$$\Rightarrow \frac{l_A}{l_B} = 6 \Rightarrow l_A = 6 l_B$$

1.29 (b)

(100 W, 200 V) (100 W, 200 V)

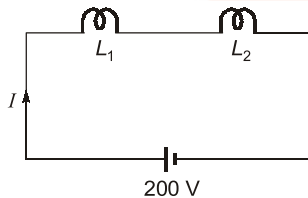

$$R_1 = \frac{V^2}{P} = \frac{200 \times 200}{100} = 400\ \Omega = R_2$$

$$\therefore I = \frac{200}{800} = 0.25\ \text{A}$$

Hence,

$$P_1 = I^2 R_1 = \left(\frac{1}{4}\right)^2 \times 400$$

$$= \frac{1}{16} \times 400 = 25\ \text{W}$$

As $R_1 = R_2$ and current is same in series,

$$\therefore P_1 = P_2 = 25\ \text{W}$$

1.30 (b) Terminal where three or more branches meet is known as node.
e.g.:

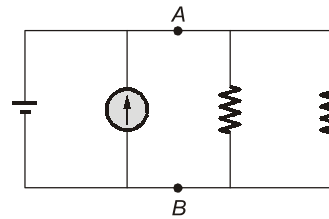

Here, 2 nodes (A and B) are there connecting 4 branches as shown.

1.31 (d) We simplify the given figure as shown below:

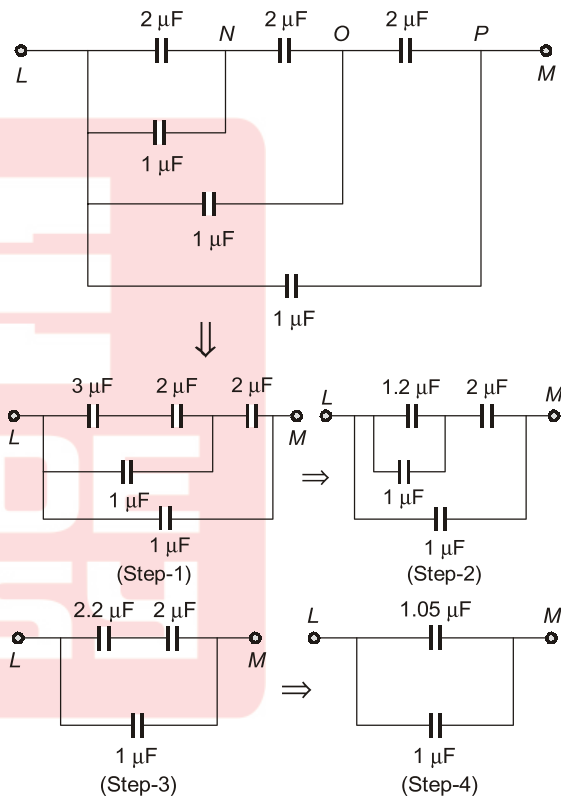

Hence, C_{eq} across the points L and M is

$$C_{eq} = 1.05 + 1 = 2.05\ \mu\text{F}$$

Using: For series combination,

$$\frac{1}{C_{eq}} = \frac{1}{C_1} + \frac{1}{C_2}$$

For parallel combination,

i.e., $C_{eq} = C_1 + C_2$

1.32 (a)

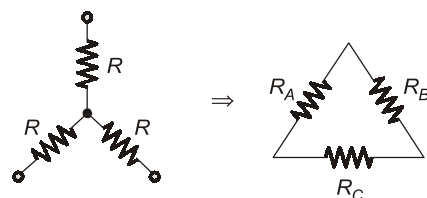

Here, $R_A = R_B = R_C$

(Since all resistors are equal in star connection)

$$\begin{aligned} \therefore R_A &= R_B = R_C \\ &= \frac{R \times R + R \times R + R \times R}{R} = 3R \end{aligned}$$

\therefore For equal value of resistances, we know

$$R_Y = \frac{R_\Delta}{3}$$

$$\begin{aligned} \text{Given : } R_Y &= R \Omega \\ \Rightarrow R_\Delta &= 3R \Omega \end{aligned}$$

1.33 (d) Normally, the bulbs are connected in parallel in house so same voltage can be assumed across them.

$$\text{Given : } P_1 = 60 \text{ W and } P_2 = 100 \text{ W}$$

$$\text{Now, } P = \frac{V^2}{R} \Rightarrow P \propto \frac{1}{R}$$

$$\begin{aligned} \text{and } R &= \frac{\rho l}{A} \\ \Rightarrow R &\propto l \quad (\because \rho \text{ \& } A \text{ is same for both as same thickness and same material}) \end{aligned}$$

$$\therefore P \propto \frac{1}{l}$$

$$\begin{aligned} \Rightarrow \frac{P_1}{P_2} &= \frac{l_2}{l_1} \Rightarrow \frac{l_2}{l_1} = \frac{60}{100} = \frac{3}{5} = 0.6 \\ l_2 &< l_1 \end{aligned}$$

Hence, 60 W bulb will have longer length corresponding to length l_1 .

- 1.34 (d)**
- An ideal voltage source should have zero source resistance because no internal voltage drop must be present ideally.
 - Also, in a similar way, an ideal current source has infinite internal resistance.

1.35 (a)

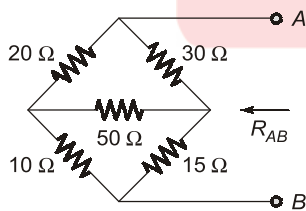

The circuit shown is a balanced Wheatstone bridge since arms ratio is same.

$$\text{i.e., } \frac{20}{10} = \frac{30}{15} = 2$$

Hence, no current flows through 50 Ω resistance.

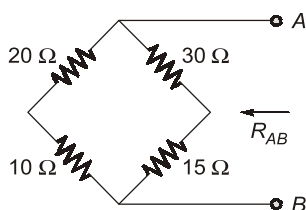

$$\therefore R_{AB} = (20 + 10) \parallel (30 + 15)$$

$$= 30 \parallel 45 = \frac{30 \times 45}{30 + 45}$$

$$\text{or, } R_{AB} = 18 \Omega$$

1.36 (a) Given circuit can be simplified as shown below :

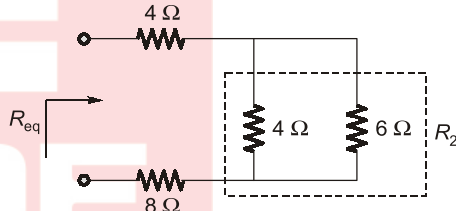
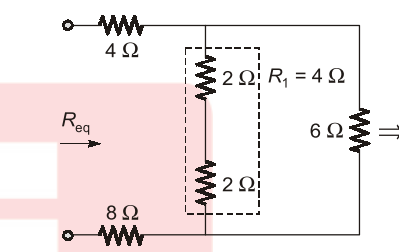
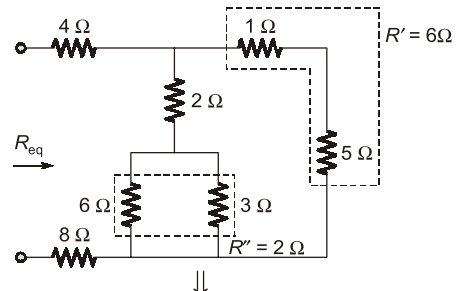

$$\Rightarrow R_2 = \frac{4 \times 6}{4 + 6} = 2.4 \Omega$$

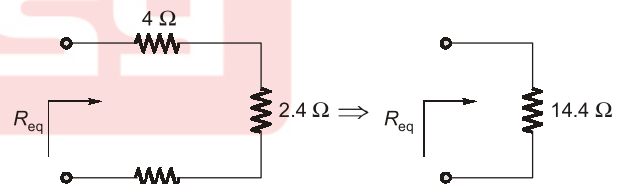

$$\begin{aligned} R_{eq} &= 4 \Omega + 8 \Omega + 2.4 \Omega \\ \text{i.e., } R_{eq} &= 14.4 \Omega \end{aligned}$$

1.37 (c) Given: $L = 2 \text{ H}$ and $\frac{di}{dt} = 10 \text{ A/sec}$.

Now, self induced emf is given by

$$V = L \frac{di}{dt} = 2 \times 10 \text{ V} = 20 \text{ V}$$

1.38 (a) Reactance of a capacitor is

$$X_C = \frac{1}{\omega C}$$

For DC circuit,

$$f = 0 \Rightarrow \omega = 0 \text{ rad/sec}$$

$$\therefore X_C = \frac{1}{0 \times 1 \text{ F}} = \infty$$